

## NOTES ON THIS MANUAL

Keep these instructions with your computer at all times. The proper set up, use and care can help extend the life of your computer. In the event that you transfer ownership of this computer, please provide these instructions to the new owner.

This manual is divided into sections to help you find the information you require. Along with the **Table of Contents**, an **Index** has been provided to help you locate information.

In addition, many application programs include extensive help functions. As a general rule, you can access help functions by pressing F1 on the keyboard. These help functions are available to you when you use the Microsoft Windows<sup>®</sup> operating system or the various application programs.

### AUDIENCE

These instructions are intended for both the novice and advanced user. Regardless of the possible professional utilization, this Notebook is designed for day-to-day household use. The functions and applications for use with this Notebook have been designed with the entire family in mind.

### DOCUMENT YOUR NOTEBOOK

It is important to document the details of your Notebook purchase in the event you need warranty service. The serial number can be found on the back of the Notebook:

Serial Number .....

Date of Purchase .....

Place of Purchase .....

## **QUALITY**

The company has selected the components in this computer for their high level of functionality, ease of use, safety and reliability. Through balanced hardware and software design we are able to provide you with an innovative personal computer useful for applications relating to both work and leisure.

We are pleased to welcome you as our newest customer.

## **SERVICE**

We are pleased to provide individualized customer service throughout the life of your Notebook. Please feel free to contact a customer service representative with any questions relating to this Notebook.

Copyright© 2004 . All rights reserved. Microsoft®, MS-DOS®, and Windows are registered trademarks of Microsoft Corporation in the U.S. and other countries. Pentium® is a registered trademark of Intel Corporation. The names of actual companies and products mentioned herein may be the trademarks of their respective owners.

This product incorporates copyright protection technology that is protected by method claims of certain U.S. patents and other intellectual property rights owned by Macrovision Corporation and other rights owners. Use of this copyright protection technology must be authorised by Macrovision Corporation, and is intended for home and other limited viewing uses only unless otherwise authorized by Macrovision Corporation. Reverse engineering or disassembly is prohibited.

**Information in this document is subject to change without notice.**

# **Table of Contents:**

<b>SAFETY AND MAINTENANCE</b> .....	<b>1</b>
<b>Safety instructions</b> .....	<b>3</b>
Data Security.....	3
Operational Safety.....	4
General Safety Information .....	4
Important Additional Safety instructions .....	5
CD-ROM/CD-RW/DVD/DVD-RW Drive safety .....	6
TFT Display Safety.....	6
Set-Up Location .....	7
Ambient Temperature .....	7
Power Adapter .....	8
Cabling .....	9
Modem .....	9
Touch pad .....	9
Battery operation .....	10
<b>VIEWS OF THE NOTEBOOK</b> .....	<b>11</b>
<b>Views of the Notebook</b> .....	<b>13</b>
Open Notebook .....	13
Front View.....	14
Left Side .....	14
Right Side .....	14
Rear Side .....	15
Device Indicators.....	16
<b>HANDLING</b> .....	<b>17</b>
<b>Getting Started</b> .....	<b>19</b>
The Windows® XP Desktop.....	21
<b>Power Supply</b> .....	<b>23</b>
On/Off button .....	23
Power Adapter .....	24
Battery Operation .....	25
Charging the Battery .....	25
Battery Power .....	25
Checking the Battery Level.....	26
Power Management .....	27
Standby Mode.....	27
Suspend (hibernate) mode.....	27

<b>Display</b> .....	<b>28</b>
Opening and Closing the Display.....	28
Screen Resolution.....	29
Connecting an External Monitor.....	29
Connecting a TV.....	31
<b>Data entry</b> .....	<b>32</b>
The Keyboard.....	32
Notebook-specific key combinations.....	32
Touch pad.....	33
<b>MAIN COMPONENTS</b> .....	<b>35</b>
<b>The Hard drive</b> .....	<b>37</b>
Important Directories.....	38
<b>The Optical Drive</b> .....	<b>39</b>
CD-RW/DVD-ROM Combo Drive.....	39
Handling Discs.....	39
Loading a Disc.....	40
Removing a Disc.....	41
Emergency Ejection of a blocked Disc.....	41
Playing Music CDs.....	42
Playing DVD Movies.....	42
Writing Discs.....	43
<b>The Sound Card</b> .....	<b>45</b>
External Audio Ports.....	45
<b>Modem</b> .....	<b>46</b>
Modem port.....	46
<b>The Network</b> .....	<b>47</b>
What is a network?.....	47
Fast Ethernet-Network.....	48
What do you need for networking?.....	48
Wireless LAN.....	50
<b>The PC Card Slot</b> .....	<b>51</b>
32-bit CardBus Port.....	51
Use of PC-cards.....	51
Installing a PC card.....	52
Removing a PC card.....	52
<b>Connection Options</b> .....	<b>53</b>
Universal Serial Bus (USB) Port.....	53
<b>Software</b> .....	<b>54</b>
Getting to Know Windows XP.....	54
Windows® XP Manual.....	54
Windows® XP Tour.....	54
Windows® XP Help and Support.....	54
Software Help.....	55
Device Drivers.....	55

Digital Signatures .....	56
Windows Activation .....	57
The BIOS Set-up-Program .....	57
Running the BIOS Set-up .....	57
Navigating the BIOS Utility .....	58
<b>FIRST AID .....</b>	<b>59</b>
<b>FAQ – Frequently Asked Questions .....</b>	<b>61</b>
<b>Data and System Security .....</b>	<b>63</b>
Data Security .....	63
Maintenance Programs .....	63
Password Reset Disk .....	63
Windows® Update .....	63
<b>System Recovery .....</b>	<b>64</b>
Restoring Microsoft Windows XP .....	64
<b>Troubleshooting .....</b>	<b>65</b>
Localize the Cause .....	65
Check Cables and Connections .....	65
The Power On Self Test (POST) .....	65
Errors And Possible Causes .....	66
Additional Support .....	67
Driver Support .....	67
<b>Maintenance .....</b>	<b>68</b>
Maintenance Instructions .....	68
Cleaning and Care .....	68
Care of the TFT Display .....	68
Transporting the Notebook .....	69
Upgrades and Repairs .....	69
Securing your Notebook .....	70
Notes for Service Engineers .....	71
<b>APPENDIX .....</b>	<b>73</b>
<b>Standards .....</b>	<b>75</b>
Electromagnetic Compatibility .....	75
Electrical Safety .....	76
Ergonomics .....	76
Supplementary Information .....	76
ISO 13406-2 Class II .....	76
Limits of Liability .....	78
Local Law .....	78
Making Copies of This Manual .....	78
<b>Index .....</b>	<b>79</b>



## Safety and Maintenance

<b>Subject</b>	<b>Page</b>
Data Security _____	3
Set-up Location _____	7
Ambient Temperature _____	7
Power Adapter _____	8
Modem _____	9
Touch Pad _____	9
Battery Operation _____	10





# SAFETY INSTRUCTIONS

---

Please follow the instructions in this section for the safe operation of your Notebook:



- **DO NOT** open the case of the Notebook, the battery or the power adaptor. When the case is open there is a danger of severe electric shock.



- **DO NOT** insert objects through the slots and openings of the Notebook. This may lead to electric shock, electrical short-circuit or fire that will damage your Notebook.
- **DO NOT** allow small children to play unattended with electrical equipment.



- **DO NOT** cover the slots and openings of the Notebook. These openings are for ventilation purposes. Covering these vents may lead to overheating.
- **This Notebook is NOT designed for use within industrial environments.**

## DATA SECURITY



The supplier does not assume liability for data loss or damage to data storage units, and no claims can be accepted for damages resulting from the loss of data or consequential losses.

## **OPERATIONAL SAFETY**

It is important to follow all of the safety instructions in this manual to ensure the safety of you and your Notebook.

### **GENERAL SAFETY INFORMATION**

If you find that:

- the power cord/power adapter is worn or damaged.
- liquid is spilled on the unit.
- the Notebook fails to work properly.
- the Notebook is dropped or the housing is damaged.

You should:

- shut-down your Notebook immediately.
- remove the power cord from the socket.
- contact Customer Service.
- do not restart unless you have contacted Customer Service.

How important is the information you will be storing on your Notebook? You need to guard against the loss of your data by making backup copies. You can backup your data onto CD, floppy disk, or other media such as Zip drives. It depends upon how much data you have. In this way, if something happens to the hard drive in your Notebook, you have another copy of your data.

## IMPORTANT ADDITIONAL SAFETY INSTRUCTIONS

When using any electronic equipment, basic safety precautions should always be taken. Following the guidelines below can reduce the risk of fire, electric shock and personal injury:

- Do not use this product near water (e.g., near a bathtub, lavatory or kitchens sink, in a wet basement or near a swimming pool).
- Avoid using a telephone/modem (other than a cordless type) during an electrical storm. There is a remote risk of electric shock from lightning.
- Do not use the telephone/modem to report a gas leak in the vicinity of the leak.



Lithium batteries cannot handle intense pressure, high temperatures or fire. Danger of explosion if replaced incorrectly. Replace batteries with a compatible type as recommended by the manufacturer. Lithium batteries are **hazardous waste** and require proper disposal. Contact the **Service Center** for additional information on battery disposal.

## CD-ROM/CD-RW/DVD/DVD-RW DRIVE SAFETY



- CD-ROM-/CDRW-/DVD-drives are **Laser Class 1** devices. These lasers **must** remain in their sealed casing.
- **Danger** — Invisible laser radiation when open. Avoid direct exposure to beam. This product is certified by the manufacturer to comply with DHHS rules 21CFR, Chapter 1, Subchapter J, applicable at date of manufacturer. Refer to optical drive labels for additional details.
- **DO NOT** remove the drive covers, as exposure to the lasers may be harmful.
- **DO NOT** look directly into the laser, even when wearing eye protection.

## TFT DISPLAY SAFETY



- To avoid damage to the TFT Display, **never** open it a **full 180°**. **Do not** forcibly open it.
- In order to avoid damage to the display, **do not** touch it with your fingers or sharp objects.
- **Never** lift the Notebook by the TFT Display; doing so could break the hinges.
- There is a risk of injury if the **TFT display breaks**. Use **protective gloves** to pack up the broken pieces and contact customer service to arrange for proper disposal.

It is important to thoroughly wash your hands after handling a broken TFT display. There is a chance that **chemicals** may have been released.

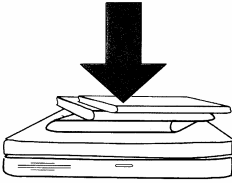

- **Never** place objects on top of the Notebook that would exert any pressure on the display. There is a danger that even slight pressure may break the TFT display.

## SET-UP LOCATION

- Keep your Notebook and all connected peripherals away from moisture, dust, heat and direct sunlight. Failure to do so can lead to Notebook malfunction or damage.
- It is highly recommended you do not use the Notebook outdoors.
- Operate the Notebook and all peripherals on a stable, balanced and vibration-free surface.
- **Do not** leave the base of your Notebook on your lap or any part of your body for a long period of time while the Notebook is turned **ON** or is charging. The Notebook can become very warm while it is turned on or charging and can cause discomfort or injury from heat exposure.

## AMBIENT TEMPERATURE

- The Notebook is most reliably operated at an ambient temperature between **+41°** and **+104° F** and at a relative humidity between **30%** and **70%** (without condensation).
- When powered off, the Notebook can be stored at temperatures between **32°** and **140° F**.

## POWER ADAPTER

- Do not open the power adapter housing. When the housing is open there is a **danger** of severe electric shock. It contains no user-serviceable parts.
- The electric outlet must be in the vicinity of the Notebook and within reach of the power adapter cables. **DO NOT** stretch the power cables tightly to reach an electric outlet.
- To disconnect your Notebook from the power source, or set the Notebook to battery operation, remove the power cord from the Notebook's power socket.
- Only use the Notebook with a power adaptor (**FSP120-AAC**) operating at **AC 115V~/60 Hz**. In European countries use the Notebook at **AC 220-240V~/50 Hz**.  
For details on power consumption, please refer to the rating plate on the rear of your Notebook. If you are unsure of the type of power supply available at the point of use, ask your local power company.
- Use **only** the supplied power cord and power adapter.
- If using an extension cord, make certain that it meets your local safety requirements. If in doubt, consult an electrician.
- To provide additional protection against electric shock, power surges, lightning strikes, or other electrical damage to your Notebook, we recommend the use of a **surge protector**.

## CABLING

- Arrange cables so no one can walk on or trip over them.
- **DO NOT** place objects on any of the cables.



**Caution** – To reduce the risk of fire, use only No. 26 AWG or larger telecommunication cords (applies to American Standards).

## MODEM

- If your system has a modem, please make sure you connect it to an **analog** telephone line only. Connecting to a digital PBX, a digital line designed for broadband services or ISDN, a shared service line or a payphone will damage the modem or the devices to which it is connected.

## TOUCH PAD

Light pressure with the tip of your finger is all that is required to operate the touch pad. Because the touch pad is electrostatic sensitive, objects cannot be used in place of your fingers. Using a pen or other object can damage the touch pad or cause the Notebook to malfunction.

## BATTERY OPERATION

To extend the life and power of your battery and guarantee secure operation, the instructions below should be followed:



- Never expose the battery to **direct sunlight** or **heat** for long periods.
- **Do not** dispose of the battery by fire as they may explode. Check with local codes for possible special disposal instructions.
- **Do not** open the battery housing; it contains no user-serviceable parts.
- Disregarding these instructions will lead to damage and under some circumstances may even cause the battery to **explode**.

- Keep the battery away from electrically conductive materials, chemical substances and cleaning agents.
- Only use the originally supplied power adapter to charge the battery.
- Fully discharge the battery before recharging it.
- Replace the battery **only** with the same type or an equivalent type recommended by the manufacturer.
- Charge the battery only until the battery charging light goes out. Also, refer to the instructions under "Checking the Battery Level" on page 26 for instructions on checking the battery level.
- Only change the battery when the unit is switched off.
- **Batteries are classified as special waste** and should always be disposed of properly. Contact Customer Service for more details.
- Keep batteries away from children at all times.
- Use only the batteries and power adapter/cord indicated in this manual.



## Views of the Notebook

<b>Subject</b>	<b>Page</b>
Open Notebook _____	13
Front View _____	14
Left Side _____	14
Right Side _____	14
Rear Side _____	15
Device Indicators _____	16



# VIEWS OF THE NOTEBOOK

---

## OPEN NOTEBOOK

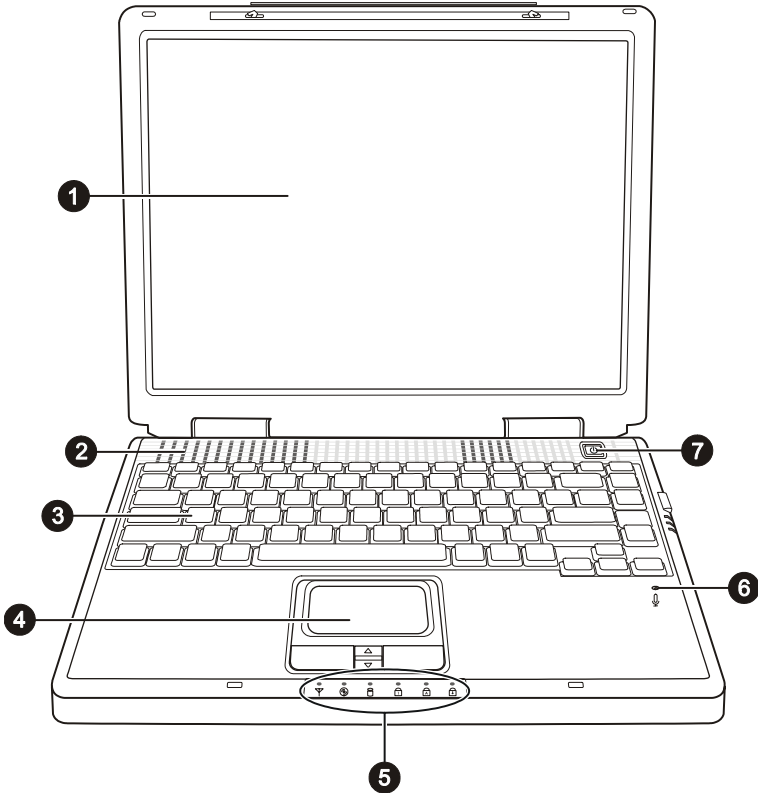

<b>1</b>	TFT display (⇒ p. 28)
<b>2</b>	Stereo Speaker
<b>3</b>	Keyboard (⇒ p. 32)
<b>4</b>	Touch pad (⇒ p. 33)
<b>5</b>	Device Indicators (⇒ p. 16)
<b>6</b>	Microphone
<b>7</b>	Power ON/OFF (⇒ p. 23)

## FRONT VIEW

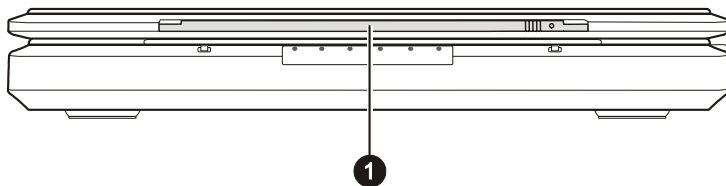

- 1 Display catch (⇒ p. 28)

## LEFT SIDE

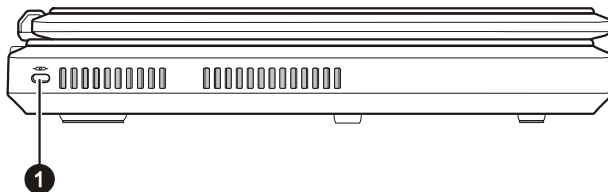

- 1 Kensington lock (⇒ p. 70)

## RIGHT SIDE

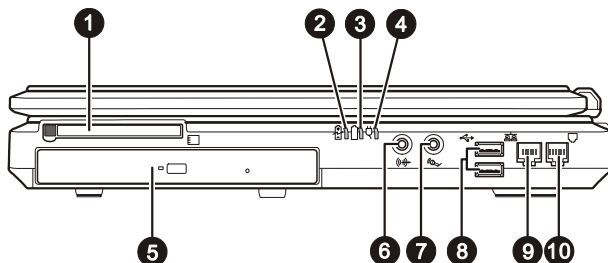

- 1 PC card slot PCMCIA (⇒ p. 51)
- 2 Battery Charge Indicator
- 3 Battery charge indicator
- 4 AC Power Indicator
- 5 Optical Drive (⇒ p. 39)
- 6 Line out (⇒ p. 45)
- 7 Microphone in (⇒ p. 45)
- 8 USB port (⇒ p. 53)
- 9 LAN port (RJ-45) (⇒ p. 47)
- 10 Modem port (RJ-11) (⇒ p. 46)

## REAR SIDE

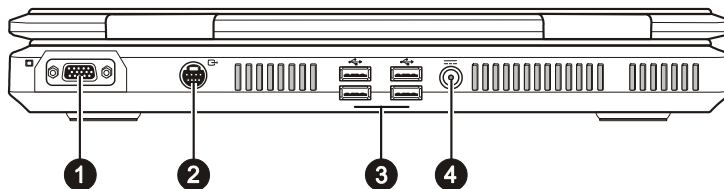







**1** External monitor (VGA) (⇒ p. 29)

**2** S-Video Video out port (⇒ p. 30)

**3** USB port (⇒ p. 53)

**4** Power socket (⇒ p. 23)

## DEVICE INDICATORS

					
<b>1</b>	<b>2</b>	<b>3</b>	<b>4</b>	<b>5</b>	<b>6</b>

LED's indicate the power and operating system states of the Notebook. The meaning of each LED is:

<b>1</b>	<p>WIRELESS LAN</p> <p>Display for wireless data exchange. (optional feature)</p>
<b>2</b>	<p>OPTICAL DRIVE ACCESS INDICATOR</p> <p>This LED lights when the Notebook is accessing the optical drive.</p>
<b>3</b>	<p>HARD DISK DRIVE ACCESS INDICATOR</p> <p>This LED lights when the Notebook is accessing the hard disk.</p>
<b>4</b>	<p>NUM LOCK</p> <p>This LED lights when NUM-Lock has been activated. It sets the keyboard so that numbers are assigned to certain characters, simplifying numerical data input.</p>
<b>5</b>	<p>CAPITAL LOCK</p> <p>This LED lights when CAPS-Lock has been activated. This sets the keyboard to capital letters.</p>
<b>6</b>	<p>SCROLL LOCK</p> <p>This LED indicates that the Scroll Lock key on the keyboard is activated. The Scroll Lock key has different functions depending on the software you are using.</p>

## Handling

<b>Subject</b>	<b>Page</b>
Getting Started _____	19
On/Off Button _____	23
Power Adapter _____	24
Battery Operation _____	25
Power Management _____	27
Opening and Closing the Display _____	28
Screen Resolution _____	29
Connecting an External Monitor _____	29
Connecting a TV _____	30
Keyboard _____	32
Touchpad _____	33





# GETTING STARTED

---

Before you get started using your notebook, first take a few moments to read the important section on **Safety**.

This Notebook comes with software **fully pre-installed**. You do not have to install any of the CDs supplied. However, with many programs (e.g., telephone CDs or encyclopaedias) it is necessary to insert the corresponding CD to access the data that is stored on it. The software will prompt you to do this when necessary.

## Step 1

Before starting the Notebook please insert the battery. For further information read the section titled "Power Supply" starting on page 23. Open the display (see page 28) and switch on the Notebook using the On/Off switch (see page 13.)



If the battery level is insufficient, connect the power adapter.



**Note:** Make sure there is no bootable CD (e.g., the Recovery CD) in the CD-ROM drive. Such disks will prevent the operating system from loading off the hard drive.

Your operating system is finished loading when a welcome screen is shown on your display.

## Step 2

The greeting procedure will guide you through a series of dialogue boxes. The information in each dialogue box will explain the steps that need to be taken.

Should you have any questions just click on  .

### Enter Personal Details

In one of the initial start-up dialog boxes a request will appear on the screen for you to enter your personal details. Please enter the requested information in the white input fields. You can select the fields by clicking on them with the mouse. When you press Enter, or click on the Continue button you progress to the next window.

### License Agreement

The greeting procedure also displays the license agreement. Please read this carefully. It contains important legal information on the use of your software. In order to see the full text, use the mouse and the scroll bar on the right side of the screen to move downwards until you have reached the end of the document. You accept the agreement by clicking on the **"I accept the agreement"** option field. Only by doing so will you be entitled to use the product under lawful terms and conditions and be entitled to open the sealed Windows<sup>®</sup> manual.

## Step 3

After the login procedure the Windows<sup>®</sup> desktop appears on your screen. This can be adjusted so that the screen of your computer looks different.

# THE WINDOWS® XP DESKTOP

After the login procedure the Windows® XP desktop appears on your screen. (Your desktop might not look exactly like the one shown here.)

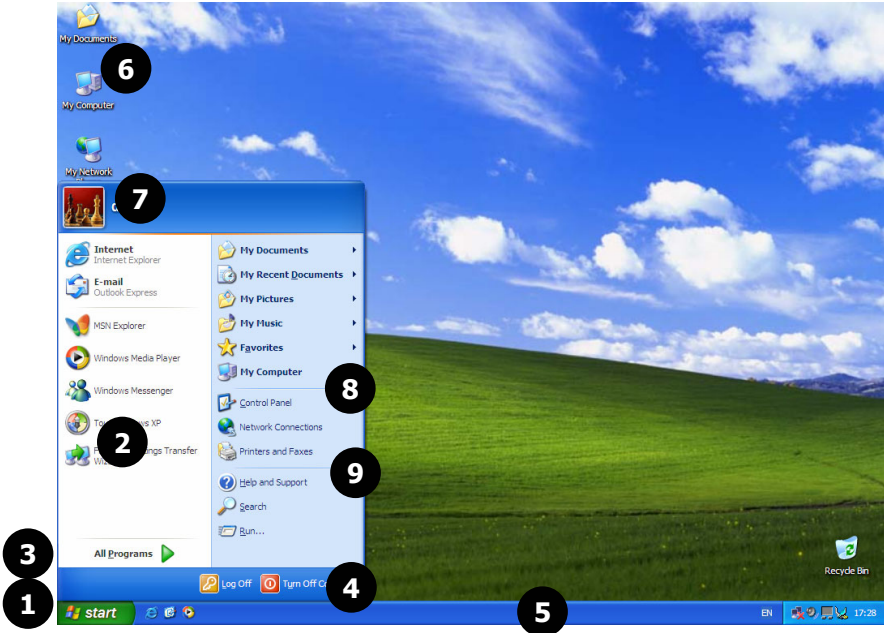

## 1. Start Button

Clicking the Start button brings up a menu where you can access help, software programs, files, and settings. For more information, click **Windows® XP Tour** on the **Start** menu.

## 2. Program Bar

The most commonly used software programs are listed here.

## 3. All Programs

All of the software programs installed on your Notebook are ordinarily listed here. Click **All Programs** to reveal an extensive menu.

#### **4. Turn Off Computer**

Click this button to shut down Windows® XP and the Notebook.

#### **5. Task Bar**

Here you receive information and status reports about Windows® XP and which programs are running.

#### **6. Desktop Icons**

Desktop icons link to their respective programs. To start a program, double-click its desktop icon.

#### **7. Logged in User**

This tells you which user is logged in to your Notebook.

#### **8. Control Panel**

You can use the icons in Control Panel to change the appearance and functionality of Windows® XP. These icons represent options for configuring your Notebook.

#### **9. Windows® XP Help**

Here you can find information on using your Notebook, networking, backup, and many other tasks.

# POWER SUPPLY

---

## ON/OFF BUTTON

The On/Off button (page 13) is used to power up/down the Notebook. Pressing the button briefly will turn off your computer using the operating system. This is the same as clicking **Start** then **Turn Off Computer**. If the button is held down for longer than 4 seconds, it will force the notebook to power down without going through the operating system shut down process. This may be useful if your computer has crashed or stalled.

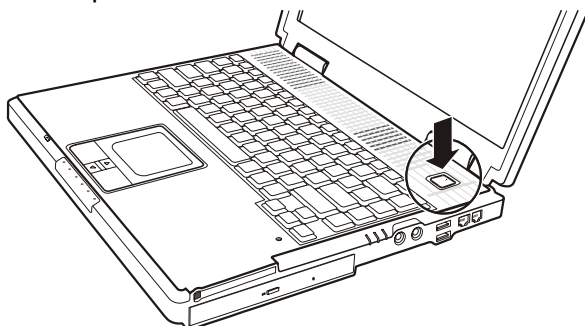

**WARNING!** Do not switch off your Notebook while the **hard disk** or the optical drive is running and the corresponding **media activity LEDs** are lit. Otherwise data may be lost. To protect the hard disk you should always wait for 20 seconds after powering down the Notebook before powering it up again.

## POWER ADAPTER

Your Notebook is supplied with a universal AC power adapter, which automatically adjusts to the available power source. The following levels are supported: **AC 100-240V~/ 50-60 Hz.** Please follow the power supply **safety instructions** found on page 8.

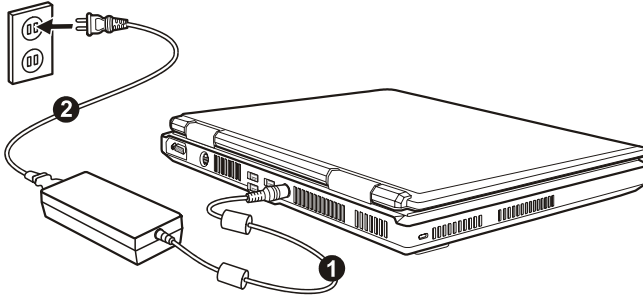

The power adapter is connected via a power cord to an AC outlet. The DC power lead from the power adapter is connected to the rear side of the Notebook (see page 15).

The adapter provides the Notebook with power and also charges the battery. The power supply indicators of the Notebook (see page 13) provide details on the operating state. The battery is also being charged when you are working on your Notebook with the power adapter.

The power adapter is still live if the Notebook is not connected with it. You should therefore unplug the power adapter from the outlet if it is not connected to the Notebook.



**WARNING!** Use only the power adapter and power cord supplied with your Notebook.

## BATTERY OPERATION

In order to extend the life and power of your battery, and to guarantee reliable operation, it is essential that the safety instructions on page 10 are followed.

### CHARGING THE BATTERY

The battery is charged via the power adapter. If the power adapter is connected, it charges the battery automatically, whether the Notebook is turned on or not.

When the Notebook is switched off, full charging takes a few hours. If the Notebook is switched on, the charging process takes a significantly shorter time. However, it is recommended that from time to time you discharge the battery completely and re-charge it afterwards with the Notebook switched off. You can discharge the battery without losing data, if you turn your notebook on without using any application and no power adapter. As soon as the battery is empty your notebook will enter the hibernate mode. We recommend doing this procedure every time you think the battery power is losing efficiency.

### BATTERY POWER

A fully charged Li-Ion battery will provide power for some hours of operation. However, the battery life will vary according to how the power saving functions are set, the way you work, the size of the main memory and the display type.

When working in Windows an audible warning alert will sound as soon as the battery level drops below a set minimum value. When this happens, the processing power is reduced in order to save power.



**NOTE:** Battery warning signals and "Low-Battery" mode will be heard immediately when the power pack is first connected.

## CHECKING THE BATTERY LEVEL

In order to check the current level of the battery, move the cursor over the power symbol in the taskbar.



When in battery mode, a battery symbol is displayed and when the power adapter is in use a power connector is displayed. If the battery is being charged the power connector has a lightning symbol superimposed over it. Further information on power settings can be obtained by double clicking on the symbol.



**NOTE:** If you ignore the warning signal when the battery level is low, your Notebook goes into suspend mode. (Depending on the BIOS/OS setting this will be Save-to-Disk or Save-to-RAM).



**WARNING!** If the battery is empty, your data will not be retained for long in Standby/Save-to-RAM mode.

**WARNING!** Never remove the battery while the Notebook is switched on or if the Notebook has not yet gone into suspend mode, as this may lead to loss of data.



## **POWER MANAGEMENT**

Your Notebook offers automatic and modifiable power saving functions that you can use to maximize battery life and reduce overall operating costs. The power saving modes are known as standby mode and suspend (hibernate) mode.

### **STANDBY MODE**

When in standby mode, the contents of the RAM of your Notebook are preserved while practically all other components of your Notebook are shut down, reducing your power consumption to a minimum. By pressing any key on the keypad, you can bring your Notebook back to the fully operational state. You will restart at precisely the line in which you were working prior to the interruption. The computer takes less time to go into and come out of standby mode, but uses more power than suspend (hibernate) mode.

### **SUSPEND (HIBERNATE) MODE**

The hibernate mode is an alternative to a complete shutdown of the Notebook. In this mode all data from RAM (system and graphic data) are copied to the hard disk as a file. As soon as the data has been safely saved, the Notebook powers down. When the Notebook is switched on again, this file is written back to RAM by the BIOS. In a few moments the Notebook is in the exact state as when it was last used. If while working on a document the Notebook is closed (assuming the correct ACPI setting), the Notebook saves the data in RAM for you automatically. You will restart at precisely the line in which you were working prior to the interruption. The computer uses no power while it is in suspend (hibernate) mode, but it takes a little longer for the computer to go into and come out of hibernation compared to standby.

## DISPLAY

---

Unlike a normal monitor, the TFT display does not produce either radiation or flicker.

### OPENING AND CLOSING THE DISPLAY

A display catch keeps the display closed when the Notebook is not in use.

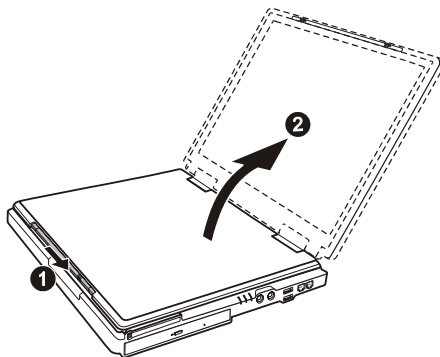

To open, use your thumbs to push the bar to the right (❶) then lift (❷) the display with your thumbs and index finger and position it as desired.



**WARNING!** The display should **not** be opened fully to 180°. Do not try to forcibly open it.

The opening and closing of the display can be assigned various functions via the Power management feature. For example, the Notebook can be programmed to power down when the display is closed.

## SCREEN RESOLUTION

The integral screen has a native resolution of **1024 x 768** pixels. Using a higher resolution can lead to distortion of the display, especially with text. Using a lower resolution may cause the display to use only a portion of the screen area.

## CONNECTING AN EXTERNAL MONITOR

The Notebook has a VGA port for connecting an external monitor. To connect and configure an external monitor:

1. Shut down your notebook.
2. Connect the video signal cable of the external monitor to the VGA port of the Notebook (see page 14).
3. Connect the external monitor to the electrical socket, power it up and start your notebook.

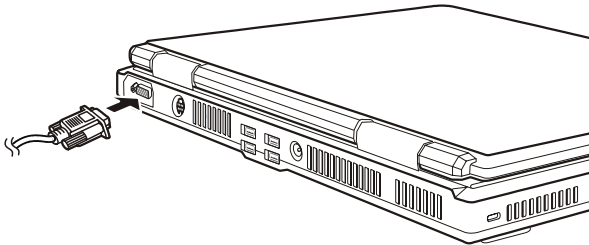

There are two options for setting up an external monitor:

### 1. Clone your Desktop

This option allows you to display the same picture on both internal and external monitor.

Press **<Fn> + <F5>** to activate the external monitor. The notebook display will be switched off. Adjust the display settings following the external monitor specification.

Press **<Fn> + <F5>** once more and both displays are switched on.

Press **<Fn> + <F5>** again to deactivate the external monitor. The notebook display will be switched on.

### 2.

## Extend your Desktop

This option extends the picture from your internal monitor to your external monitor. Windows can be switched from one monitor to the other.

This option does not support the key combination **<Fn> + <F5>**.

Right click anywhere on your desktop and select "**Properties**" to start the "**Display Properties**" program.

- Select the "**Settings**" tab and left click on the second display **1**.
- Check the option "**extend my Windows desktop onto this monitor**" **2** and press "ok".
- To deactivate the extension uncheck the option "extend my Windows desktop onto this monitor".

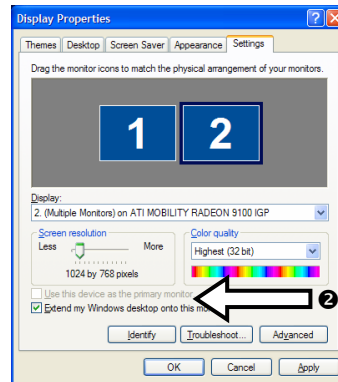
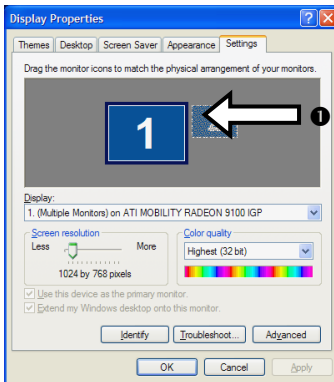

You can change the resolution and colour depth for either display in this screen. However, you may have to decrease the depth of colour if you increase the resolution since the video memory has a limited capacity.

## CONNECTING A TV

The Notebook has a port for connecting a TV. To connect and configure the Notebook for a TV:

1. Shut down your notebook.
2. Connect the signal cable of the TV to the optional composite video adapter provided with your notebook, and then connect the other end of the adapter to the TV out port of the Notebook (⇒ p. 14).
3. First turn on your TV and then turn on your notebook.

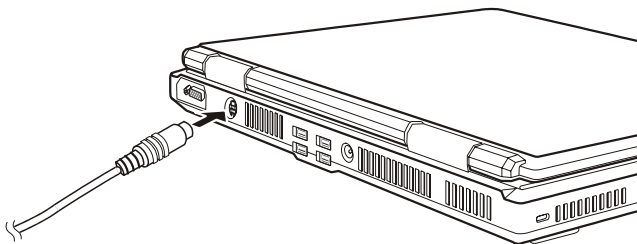

Switch on your notebook and boot it properly.

- ⇒ If the option **Extend Windows Desktop to this Monitor** in the program **Display Properties** is activated, then it must be deactivated first in order to change the display to the TV set.





















# DATA ENTRY

---

## THE KEYBOARD

By dual assignment of certain keys you have the same range of functions available to you as with a normal Windows keyboard. Some functions are input using the **Fn** key, which is normal on notebook computers.

### NOTEBOOK-SPECIFIC KEY COMBINATIONS

		Switches the wireless LAN on and off.
		Switches the loudspeakers on / off.
		Decreases the volume.
		Increases the volume.
		Toggles the display screen between internal monitor, external monitor and simultaneous display.
		Reduces screen brightness.
		Enhances screen brightness.
		Toggles the battery beep on and off.
		Switches the backlight off to save power. Pressing <b>any</b> key switches the backlight on again.
		Power saving functions. This key combination is set to <b>power down</b> by default. To adjust this key to your own needs go to display <b>properties</b> in <b>power saving</b> .

## TOUCH PAD

The touch pad's primary function is to move the cursor around or select items displayed on the screen with the use of your fingertip instead of a mouse. It is positioned in front of the keyboard (see page 13). The pointer follows the direction which is specified by moving your finger or thumb over the touch pad.

**DO NOT** use a ball-point pen or other object on the touch pad, as this could damage or cause a malfunction of your touch pad.

Below the touch pad are the left and right mouse buttons which can be used as on a normal mouse. You can also perform a direct click or double click using the touch pad by tapping the surface briefly once or twice.

In the Windows Control Panel you will find a number of useful settings that will make using the touch pad easier. If the Control Panel is in category view, click **Printers and Other Hardware** and then **Mouse**. In classic view, double-click **Mouse**.





## Main Components

<b>Subject</b>	<b>Page</b>
Hard Drive _____	37
Optical Drive _____	39
Sound Card _____	45
Modem _____	46
Network _____	47
PC Card Slot _____	51
Connection Options _____	53
Software _____	54



# THE HARD DRIVE

---

The hard drive is the main storage medium combining large storage capacity and rapid data access.

The Windows operating system cannot use the full capacity of the hard drive, which means that there will be a difference between the capacity that the BIOS displays and what the operating system displays.

The hard drive contains the operating system of the computer, other application programs and backup files. These programs and files are pre-installed on your Notebook, so you may note that some of the space on your hard drive is already taken.

Whenever the computer is accessing the hard disk, the corresponding LED illuminates (see page 16).



**WARNING!** Never switch off the computer while the busy indicator is lit since this may result in loss of data.

If you are looking for a file on the hard drive and you know the name, go to Search on the Start menu to find the file. Following is some general information on where you might find some common files.

Usually your hard drive is divided into several partitions, as shown below. The partitions of your hard drive may vary from what is shown here.

Local Disk	C:	Windows XP Software programs Your documents
------------	----	---

## IMPORTANT DIRECTORIES

The most important directories preinstalled on your Notebook are shown below. These directories may vary from what is shown here.

**Caution:** Don't delete files unless you know what they are. Windows XP might require these files for your computer to operate correctly. Also, do not alter or resize the partitions – this will make it difficult to restore your Notebook to the factory settings.

**C:\** This is the main hard disk drive partition for your Notebook. It is where your program files, settings, and documents are stored, as well as files necessary for running Windows XP.

**C:\Program Files** Includes files belonging to software programs.

**C:\Windows** The main directory for Windows XP.

**C:\Documents and Settings** Includes the settings and documents for all users.

**C:\Applications\Driver** Drivers for internal Notebook components.

**C:\Applications\Tool** Includes installation files for software that came with your Notebook.

# THE OPTICAL DRIVE

---

## **CD-RW/DVD-ROM COMBO DRIVE**

Your Notebook has a CD-RW/DVD-ROM combo drive. This drive can play everything that a DVD-ROM drive can play: DVD movies, music CDs, and data DVDs and CDs. It can also run software programs from CDs and DVDs. In addition, this drive can write data and music CDs and copy CDs. It writes to CD-R or CD-RW.

### **HANDLING DISCS**

To maintain the life of CD and DVD discs, observe these guidelines.

- Avoid radiation by direct sunlight (UVA/UVB).
- Avoid scratches and damage to the disc surface.
- Avoid extreme temperatures.
- Do not attach labels or paper to DVD discs.
- Do not use record-cleaning or anti-static agents to clean your discs.

We also recommend that you avoid specially shaped discs such as hearts or polygons, or discs that are not standard size. Do not use warped or cracked discs as they may cause damage to your drive.

## LOADING A DISC

⇒ **Tip:** Do not place protective foils or other stickers on your CD's. To avoid damage to your drive, do not use deformed or damaged CD's. **Attention:** Do not use scratched or dirty disks, discs with pieces broken off or disks of poor quality. Because of the high speeds in the drive the disks might break and damage your data as well as your drive. Examine the disks before you enter them. If damage or dirt is visible, you should not use them. Damage caused by faulty media is excluded from warranty and their repair must be charged.

1. Press the eject button on the front of the drive to open the tray.
2. Place the disc on the tray so that it lays flat with the label facing upward.
3. Gently push the tray in to close it.

Many discs automatically start when they are loaded and launch a playback software program. In some cases you might need to start a program (for example, a DVD player program).

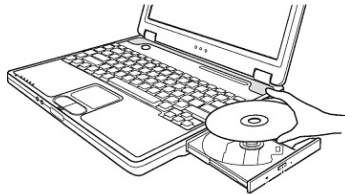

## REMOVING A DISC

Press the eject button on the front of the drive to reject the disc.



**WARNING!** While the Notebook is accessing the CD-ROM drive the media activity indicator is lit. Do not try to remove the CD from the drive while this LED is lit.

## EMERGENCY EJECTION OF A BLOCKED DISC

If the tray fails to open automatically, then the tray can be opened manually provided there is an opening for emergency ejection. (⇒ p. 14).

Restart your notebook and if the tray is still locked proceed as follows:

1. Shut down Windows and switch off your notebook.
2. Insert a long thin object (like a straightened paper clip) into the emergency ejection opening until you feel resistance.
3. Press lightly and the tray will open.
4. Remove the disc and restart the notebook.

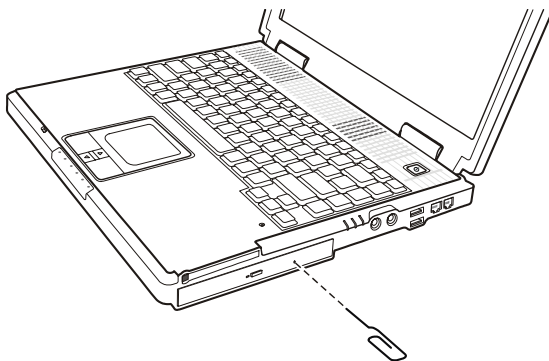

## PLAYING MUSIC CDs

Windows Media Player and MusicMatch Jukebox can be used to play music CDs. Please refer to the documentation for these programs to decide which program you would like to use.

## PLAYING DVD MOVIES

To play DVD movies on your Notebook, you need a DVD playback software program, such as CyberLink's award-winning PowerDVD. To play DVD movies using this software, insert a movie DVD into the DVD-ROM or DVD-RW drive, then click **Start**, then **All Programs** and select PowerDVD.

In spite of the high storage capability of the DVD, the data must be extremely compressed in order for a complete feature film to be stored. This extreme compression combined with exceptional picture quality is provided by the MPEG2 image coding method on the DVD. This places high demands on the Notebook's processor, so when playing a DVD please close all other applications. To increase Notebook performance, you may also wish to purchase a plug-in MPEG2 decoder card, which has its own decompression processor and will thus free the Notebook's processor.



**NOTE:** The decoding software included with your Notebook may be changed for regional DVD decoding up to five times, after which the drive will only play DVD movies for the region setting last entered.



## WRITING DISCS

You can use your CD-RW/DVD-ROM combo drive to write ("burn") data and music CDs.

A data CD is a compact disc (CD) used to store PC data (for example, files and folders you have on your hard disk).

A music, or audio, CD is a compact disc (CD) used to record music that you can play on your home or car stereo CD player. Using a CD-R instead of a CD-RW for music CDs will help ensure a greater level of compatibility with conventional CD-players.

There are several different options for burning CDs. The first step for using any of these options is to insert a blank recordable CD into your combo drive.

Nero Burning ROM can create different types of audio, video, and data CDs quickly and easily. Click **Start**, then **All Programs**, then **Nero**, then **Nero OEM** to access Nero Burning ROM. Follow the step-by-step instructions given by the software wizard to create a CD.

Windows XP includes functionality for quickly and easily creating data CDs:

1. Select the files or folders you would like to write to your CD. To select more than one file, hold down the CTRL key while you click the files you want.
2. In the File and Folder Tasks menu on the left (Picture Tasks if the files are located in My Pictures), click **Copy this file**, **Copy this folder**, or **Copy the selected items**. If you do not see the File and Folder Tasks menu, select **Tools** on the main menu, then **Folder Options**. Under Tasks on the General tab, select **Show common tasks in folders**.
3. In the Copy Items dialog box, click the CD-RW, and then click **Copy**.
4. Double-click **My Computer**, then the CD-RW. Windows displays a temporary area where the files are held before they are copied to the CD. Verify that the files and folders that you intend to copy to the CD appear under Files Ready to be written to the CD.

5. Under CD Writing Tasks, click **Write these files** to CD. Windows displays the CD Writing Wizard. Follow the instructions in the wizard.

Music jukebox and media player programs (such as Windows Media Player) often offer alternatives for burning audio CDs. Refer to the help within the program for more information.

You can also purchase third-party CD burning software for writing files to a CD-R or CD-RW disc.

More information about copying CDs reliably can be found in the "Technical Reference" section of this manual under "CD Facts."



**WARNING!** Unless you own the copyright or the permission of the owner of the copyright, unapproved copying of copyrighted CDs or DVDs violates national and/or international laws and can result in serious punishment.

# THE SOUND CARD

---

Your Notebook has an integrated stereo sound card (on-board) with 16-bit and 3D spatial sound effects (3D). The sound card is compatible with the industry standard **Sound Blaster** and **Microsoft Sound System Version 2.0**. This guarantees optimal support for all popular programs and games.

If you wish to alter the base volume, click on the loudspeaker symbol in the task bar. A double click opens the sound mixer.

By means of the key combinations (⇒ page 32) you still have the possibility to regulate the volume.

By using the keys **Fn+F4** you increase the volume and by using **Fn+F3** you decrease it.

## EXTERNAL AUDIO PORTS

<b>Microphone in</b> (⇒ side 14)	▶ For recording via an external microphone.
<b>Audio out</b> (⇒ side 14)	▶ For sound reproduction via external stereo equipment such as loudspeakers (active) or headphones.

Your Notebook has a loudspeaker, so you can always playback sounds without additional equipment. The connection of a Hi-Fi system increases the sound quality significantly.

# MODEM

---

The modem is fitted with an RJ-11 interface, into which a standard telephone lead can be plugged.



**WARNING!** Use only with an analogue telephone line. The modem cannot withstand the voltage levels of digital telephone systems such as PBX or lines such as ISDN or Broadband services.

## MODEM PORT

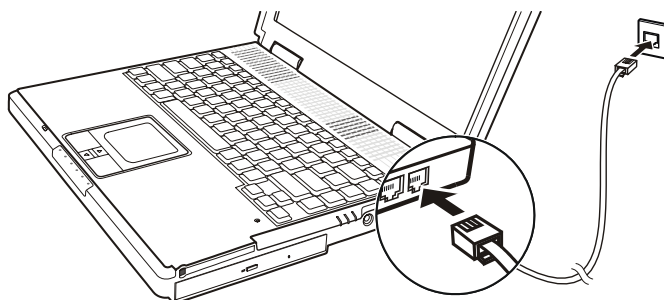

Insert one end of the RJ11-connection (telephone plug connector) into the modem/network interface and the other into an analog telephone socket that is easily accessible.



**NOTE:** Do not place the Notebook in Suspend (or Sleep) mode if you are connected to your Internet provider, since this will cause the modem connection to be lost.

## **WHAT IS A NETWORK?**

A network means connecting your Notebook to one or several other computers. Users can transfer data between computers and share resources such as printers, modems and hard disk drives.

Here are some practical examples:

- You can exchange E-mail and manage appointments in an office.
- Users can share a printer in a network and save their data on a central server.
- Users can share one modem among computers for Internet access.
- Two or more computers can be connected to play network games or share data.

## FAST ETHERNET-NETWORK

Your PC has a Fast Ethernet Network connection. You can use this to connect to a network.

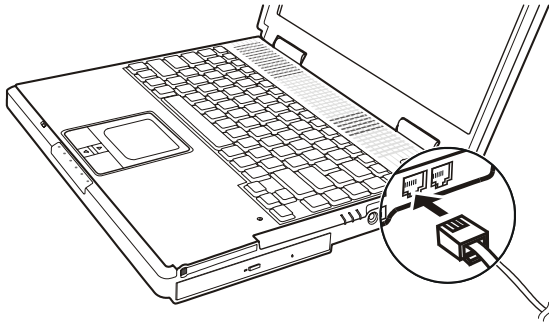

Connect one end to the RJ45 connection (Western plug) at the network interface of your Notebook (⇒ p. 14) and the other to another PC or a hub/switch.

The Windows XP Help and Support Centre offer extensive information about networking your PC. You can access this information by clicking on **Start**, then **Help**.

### WHAT DO YOU NEED FOR NETWORKING?

Some requirements have to be fulfilled to successfully network computers:

1. The Notebook must have a network card that supports the same network technology as the other computers on the network. Unless otherwise quoted, your Notebook will support the current **Fast Ethernet** (10/100 Mbit) standard.
2. The network cards must be connected. You need a Shielded Twisted Pair-cable (CAT5) that has an **RJ-45**-connector.
  - If you want to directly connect two PCs you need a **Cross-Link** cable.
  - If more PCs must be connected you need a supplementary distributor (**Hub** or **Switch**) and a Patch cable.
3. All connected PCs need a network **operating system**. Windows® can act as a network operating system.
4. All networked PCs must speak the same "language" to understand one another. They use protocols for this purpose. The setting of protocols, therefore, must be the same for all networked PCs.

## TROUBLESHOOTING WITHIN THE NETWORK

 Why does an error message appear when I click on the network environment?

 The **computer name** must be unique on the network and may not be the same as the **task group**.

 It appears that the network boards are unable to communicate. What might be the problem?

 Maybe one of the used network boards works with a **different speed** (e. g. 10 instead 100 Mbit) and your network computer is unable to recognize this. If necessary, set the network driver to the compatible speed.

If two PCs should be linked you require a **cross-link cable**, otherwise use a **patch** cable.

In addition, check the **protocols** and the **configuration**.

 The data transmission is incorrect or very slow. What might be the problem?

 Maybe you have the wrong cable (UTP / CAT3 or lower) or the problem is the proximity of a power cord or another source of interference.

For further hints on troubleshooting search for “network errors” in Windows Help and Support.

## WIRELESS LAN

Wireless LAN is an optional feature. This function allows you to create a wireless network link with an access point or directly with another wireless-enabled PC.

⇒ **ATTENTION:** Make sure the Wireless LAN option is switched OFF in any environment where it might interfere with critical and sensitive devices, e.g., on aircraft, in hospitals and other medical centres, etc.

### CONDITIONS

An access point is a wireless transmitter that communicates with your notebook and controls access to the network connection (e.g., a home network or a broadband connection such as DSL).

Wireless access points are often found in offices, airports, universities or Internet cafés. They offer access to networks or to the Internet. **Access authorizations** are normally needed. A fee may be required to use a public access point. To set up a wireless network to share Internet access, files, and printers at home, you will need an access point, a router, and a broadband (DSL or cable) modem. Some access points can also serve as a router and/or a broadband modem. Check with your retailer or Internet Service Provider to find the best solution for your needs. A link to another computer with wireless LAN functionality can also be created **without an access point**. This will allow you to share files, but you will need an access point and a router to share an Internet connection.

The wireless network link works according to standard **IEEE 802.11g** which is also compatible with the IEEE 802.11b standard. The standard 802.11a is not supported. If encrypted transmission is used, this must operate according to the **same principle on all devices**. Encryption is a method of protecting the network from unauthorized access. The transmission speed (max. 54 Mbps) can vary according to the **distance** and **loading** of the partner.



# THE PC CARD SLOT

---

The PC card slot on the left side (see page 14) of the Notebook can be used to operate credit card-sized PC cards. Most PC cards are communications or interface devices such as ISDN-, Fax-modem-, Network- or SCSI-adapters.

Some PC cards contain memory chips or hard disks for data storage. If you use such cards with your Notebook, the system assigns the card a drive name, so that you may access the resources. The PC card drive in your Notebook supports PCMCIA 2.1 - (Type II), and CardBus (Type I) cards. Cards of Type I are 3.3 mm, and Type II 5 mm thick.

## **32-BIT CARDBUS PORT**

CardBus cards have a 32-bit architecture with which high data transfer speeds of up to 132 MB can be achieved, similar to PCI. In this way your Notebook can also support data intensive devices such as 100Mbps Fast Ethernet, Fast SCSI peripherals and video conferencing devices.

The CardBus port is backward compatible with 16-bit PC cards with a 5V power supply, though the CardBus only requires a power-saving 3.3V.

## **USE OF PC-CARDS**

In order to run a PC card, special software is needed (drivers, etc.). The card manufacturer usually supplies this software. Support for the card port is a component of Windows® and at present represents the optimum in operational smoothness. You should consider this point when choosing between alternative operating systems.

## INSTALLING A PC CARD

Follow the PC card installation instructions that are given for use under Windows® and have the necessary driver software ready. Once you have started Windows®, slip the card carefully into the slot provided.

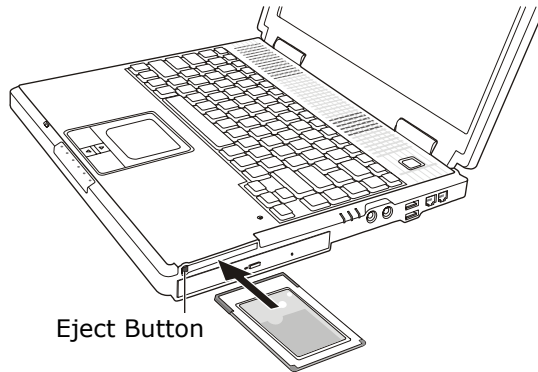

When the card is fully inserted two audible signals will be heard, provided it has been correctly recognized and successfully configured.

If only one signal is heard, this signifies a problem with the card recognition. In this case, follow the instructions that accompany your new PC card.

## REMOVING A PC CARD

To remove your PC card:

1. Press the eject button next to the slot.

## CONNECTION OPTIONS

---

The Notebook has a number of input and output interfaces for connection of peripheral devices such as a printer, scanner, keyboard, and so on. This section presents the individual ports. For further information, refer to page 15, where the positions of the respective ports are described.

### UNIVERSAL SERIAL BUS (USB) PORT

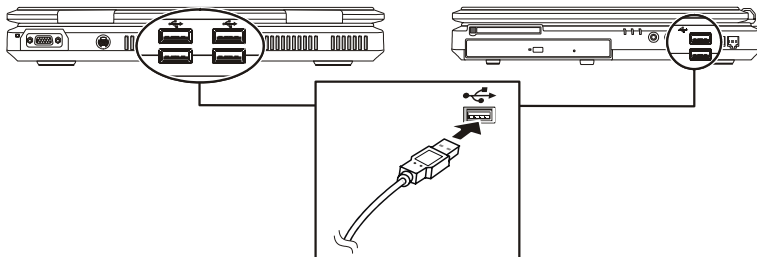

USB ports provide an easy way to connect many peripheral devices to your PC. You can use any USB device with any USB port. **6 USB** ports are located on the back panel of the Notebook for your convenience. Some USB devices require that you reinstall software drivers when you connect the device to a different USB port than the one originally used. This can be avoided by always using the device with the same USB port. Devices connected directly to the USB bus should not draw more than 500 mA. Should the devices need more power than this, it will be necessary to provide a powered hub. The data transfer speed is 1.5 Mbit or 12 Mbit, depending on the device connected.

# SOFTWARE

---

There are many kinds of help and information for using your PC. This section tells you where to get help with the Microsoft® Windows® XP operating system, software programs, and the PC.

## GETTING TO KNOW WINDOWS XP

### WINDOWS® XP MANUAL

This printed manual provides general information about the operating system. We recommend that all beginning users or users of previous versions of Windows® read this information. It can be found with the CDs in the accessory box that came with your PC.

### WINDOWS® XP TOUR

Windows® XP includes a tour that you can take to familiarize yourself with the operating system. This tour can usually be found by clicking on the **Start** menu. You can also find the tour by selecting **All Programs**, then **Accessories**.

### WINDOWS® XP HELP AND SUPPORT

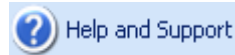

An answer to almost every question can be found in this program. You'll find it in the **Start** menu.

## SOFTWARE HELP

Many software programs incorporate extensive help functions. As a general rule, you can access help functions by pressing F1 on the keyboard. Many software programs include Help as an option on the menu at the top of the screen or window. They may also provide an icon (or icons) with a question mark on them that you can click to access more information.

The software included with the Notebook was pre-installed at the factory.

During software installations, important files can be changed or even deleted. We recommend that you set a Windows® XP recovery point before installing software (p. 64).

For specific installation information, refer to the documentation that came with the software program. Here is a typical installation procedure.

1. Load the software program installation disc in the combo drive.
2. Most installer programs start automatically after a few moments.

If the installer program does not start automatically, you can manually start it by double-clicking My Computer, and then double-clicking the drive letter where you loaded the software program installation disc.

3. Follow the instructions given by the program.

## DEVICE DRIVERS

If you install external devices, such as printers or digital cameras, you may also need to install device drivers. The drivers will be included with your peripheral devices. These are occasionally updated by the manufacturer. Check with the manufacturer of your peripheral device to find out if you have the most recent version of your device drivers.

## DIGITAL SIGNATURES

When installing software or drivers, you may receive the message “The software you are installing has not passed Windows Logo testing to verify its compatibility with Windows XP.” Although the software lacks the digital signature, it may work properly. Click on “Tell me why this testing is important” to get detailed information. Click on “Continue Anyway” to continue to install your software.

To set file signature verification options for Windows XP:

1. Click **Start**, then **Control Panel**. Double-click **System**.
2. On the **Hardware** tab, select **Driver Signing**.
3. Under **File Signature Verification**, select one of the following:

**Ignore** allows all device drivers and software to be installed on this PC regardless of whether they have a digital signature.

**Warn** displays a warning message when you attempt to install a software program or device driver without a digital signature.

**Block** prevents installation programs from installing device drivers without a digital signature.

If you are logged on to your PC as an administrator, you can click **Apply setting as system default** to apply the selected setting as the default for all users of your PC.



**WARNING!** During software installation important files can be changed or deleted. To avoid problems in using older files after installation, make sure to safeguard your hard disk.

## WINDOWS ACTIVATION

Microsoft is committed to the protection of intellectual property rights and the reduction of software piracy. Windows XP contains software-based product activation technology. Your copy of Windows XP has already been activated for your Notebook. However, product activation is needed if some components of your Notebook have been replaced or you use non-authorized BIOS. If necessary, you can activate Windows XP as often as needed.

You will probably need to activate Windows XP by telephone even if Internet Activation is available. This is due to the pre-activated SLP version that runs with a special Product-ID. However, activation needs your unique Product ID that can be found on the **Certificate of Authenticity** sticker on your Notebook housing. When you call, please inform the agent that you are running an OEM (SLP) version of the software.

## THE BIOS SET-UP-PROGRAM

In BIOS setup (Basic Configuration) there are a number of configurable parameter settings available for your Notebook. For example, you can change the operating mode of the interfaces, security features or power management.



**WARNING!** The Notebook is factory pre-set to guarantee optimum operation. Only modify the parameters if necessary and if you are familiar with the configuration options.

## RUNNING THE BIOS SET-UP

You can only run the BIOS configuration program at system start-up. If the Notebook has already started, power it down and then up again. Press the **F2** function key in order to start the BIOS-SET-UP.

## NAVIGATING THE BIOS UTILITY

There are six menu options: System Information, Basic System Settings, Start up Configuration, Onboard Devices Configuration, System Security and Load Default Settings.

To enter a menu, highlight the item using the cursor up/down keys; then press **Enter**.

While in a menu, follow these instructions:

- Press the cursor up/down keys to move between parameters.
- Press the cursor left/right keys to change the value of a parameter.
- Press Esc while you are in any of the menus to return to the main menu.



**Note:** If you are unsure if your parameter settings are correct, you should load the "**Set-up-Defaults**".





## First Aid



<b>Subject</b>	<b>Page</b>
FAQ _____	61
Data and System Security _____	63
System Recovery _____	64
Troubleshooting _____	65
Maintenance _____	68











# FAQ – FREQUENTLY ASKED QUESTIONS

---

-  When do I have to activate Windows?
-  Your software has been preactivated in the factory. An activation will only be required, if ...
- ... several components are replaced by others.
  - ... you installed a new motherboard.
  - ... a different BIOS version has been installed.
  - ... you install the software to another computer.

-  What is the Windows activation?
-  Your operating instructions include a chapter about this subject.

-  How do I perform a data backup?
-  Use the program Backup for this.
- It is important that you follow the operating instructions of these programs.
- Make a backup and another backup of selected data to an external medium (CD-R, CD-RW, DVD-R, DVD-RW, SD card, etc.), to familiarize yourself with the technique.
- A backup is unsuitable if you are not able to recover the data, the medium (floppy disk, CD-R, etc.) is defective or no longer available.

-  Do I still have to install the enclosed CDs/DVDs?
-  No. Basically all programs are already preinstalled. The disks are only intended as backup copies.
-  When is the recovery of the factory setting recommended?
-  This method should be chosen as the last resort. Read chapter "**System recovery**" on page 64 concerning the possible alternatives.
-  Why is the boot partition missing when booting from the support/ application CD?
-  The first partition is formatted with the file system NTFS. Compared to FAT32 this file system offers more security and a more efficient access. However, NTFS partitions can only be read from operating systems supporting this. This is not the case in the aforementioned CD.

# DATA AND SYSTEM SECURITY

---

The programs described below are part of your Windows operating system. You will find additional information on these programs in the Windows Help file.

## DATA SECURITY

Back up data regularly on external media such as a CD-R or CD-RW. Windows offers both a **Backup** program and a **Files and Settings Transfer Wizard**.

Both programs are found in **Accessories/System Tools** within the Start menu. You should make a backup disk with all your passwords and the operating system's original configuration.

## MAINTENANCE PROGRAMS

You can avoid some hardware and software errors with disk maintenance programs such as **Disk Defragmenter** and **Disk Cleanup**. The program **System Information** can also be helpful since it gives you detailed information about your system configuration. You will find these programs in **Accessories/System Tools**.

## PASSWORD RESET DISK

To protect individual user accounts from complications resulting from lost passwords, users should create a password reset disk and keep it in a safe place. Windows Help describes how to create a password-reset disk.

## WINDOWS<sup>®</sup> UPDATE Windows Update

To keep your notebook up to date to the latest version, we recommend to regularly run Windows Update from the Internet. To select this option go to **Start** ⇒ **Programs** ⇒ **Windows Update**.

⇒ The update can only be executed via the Internet. Ensure that you are on-line with your notebook when downloading the updates.

# SYSTEM RECOVERY

---

Before performing a recovery, you should review the "Troubleshooting" section in this manual to see if you can resolve the problem. If not, it is possible that a software file required by Windows XP to operate the computer was damaged or deleted.

## RESTORING MICROSOFT WINDOWS XP

Windows XP System Restore allows you to set "recovery points." This feature enables you to take a snapshot of the current system configuration, which you can return to should an application, device, or driver cause instability in the system.

While Windows XP automatically creates recovery points, you can also set them manually. In addition, you can configure the maximum amount of memory used for this.

To use System Restore to set recovery points or restore your system, click the **Start** menu, then choose **All Programs**, then choose **Accessories**, then choose **System Tools**, then choose **System Restore**. Select the task that you would like to perform and follow the on screen instructions. For detailed information refer to Windows XP Help and Support.

System Restore includes various functions to help ensure that your Notebook and installed applications and devices work correctly. These functions assist you in solving the problems which might occur by adding, deleting or replacing files required for proper functioning of Windows XP, and your software and devices. The restore function you use depends on the type of problem or error.

In general, it is a good idea to set a recovery point before installing a new software program or driver. If the system becomes unstable during or after the installation, you can usually return to a workable configuration without deleting newly created documents.

# TROUBLESHOOTING

---

## LOCALIZE THE CAUSE

Errors can have simple causes, but sometimes they are caused by faulty equipment. We would like to give you some tips to help solve common problems. Should these instructions not lead to success, please feel free to contact us.

## CHECK CABLES AND CONNECTIONS

Visibly check all cables and connections. Should all lights be off, check whether all equipment is supplied with power.

- In battery mode, connect the Notebook to the power adapter and ensure that the battery is charged up.
- If you are operating the Notebook with the power adapter, check the electrical socket, power cord and all switches in the circuit of the electrical socket.
- Switch off the Notebook and check all cable connections. Check the connections to peripherals. Do not exchange cables, even though they may look similar. The polarity in the cables may be different. When it is confirmed that the Notebook has power and all connections are correct, turn the Notebook on again.

## THE POWER ON SELF TEST (POST)

The Power On Self Test (POST) is executed during each boot process to test the memory, motherboard, display, keyboard and other components. If the Notebook does not pass the POST but beeps several times, or if the screen remains blank, call your Notebook support technician.

## **ERRORS AND POSSIBLE CAUSES**

The display is blank:

- Confirm that the system is not in stand-by mode. Press any key on the keyboard to test this.

Wrong Date and Time:

- Double-click the clock on the taskbar and correct the date and time.

An error message appears during boot-up:

- You may have a floppy disk in the disk drive so the system is looking for an operating system on that floppy. Remove the disk and press any key.

No data can be accessed from the optical Drive:

- Check whether the CD is inserted correctly.
- Is the CD-ROM displayed in Windows Explorer? If so, test another CD.

The Printer does not work:

- Check the printer cable.
- Do a Printer Self Test.
- Should several pieces of equipment be operating from the same port, check all peripherals and reinstall the drivers.
- If you have access to the Internet, download and install the latest drivers from the manufacturer's Web site.

The mouse does not work.

- Check the cable connection.



## **ADDITIONAL SUPPORT**

If the suggestions in the above section have not solved your problem, please contact customer care and we will attempt to help you solve the problem. Before you call, however, please have the following information available:

- How is your computer configured?
- What additional peripherals do you use?
- What messages, if any, appear on your screen?
- What software were you using when the error occurred?
- What steps have you already undertaken to solve the problem?
- Have you upgraded or removed drivers or hardware?
- Can you manually repeat the problem?
- If you have been given a customer number previously, please have this available.

## **DRIVER SUPPORT**

This Notebook has been extensively tested in our laboratories with a large number of compatible devices. It fulfils all required standards and complies with the standard "Designed for Windows", which certifies utmost compatibility. However, the software drivers for individual components are updated from time to time. This is a regular process provided by the manufacturer to mend possible compatibility problems that may occur with components (e.g., programs or hardware) that were not tested at the time of your Notebook's manufacture. Driver updates and the latest information on your product are available on the Internet.

## MAINTENANCE INSTRUCTIONS

This section provides information on the proper maintenance and care of your Notebook. Following these measures can extend its lifetime.

### CLEANING AND CARE



- **Warning!** There are no user-serviceable or user-cleanable parts inside the Notebook housing. Never open the Notebook housing.
- **DO NOT** use any solvents, corrosive or gaseous cleaning agents.
- **DO NOT** use CD-ROM cleaning disks or similar products that clean the lens of the laser to clean your CD-ROM/CD-RW/DVD/DVD-RW drive.

- Before cleaning, always remove the power adapter plug and all connecting cables.
- Only use a damp, lint-free cloth to clean the Notebook.

### CARE OF THE TFT DISPLAY

- Always close the Notebook when not in use. Avoid touching or scratching the surface of the screen as it is easily damaged.
- Make sure that no water drops are allowed to remain on the screen. Water can cause permanent discoloration.
- Clean the screen with a dry, soft, lint-free cloth.
- Do not expose the screen to bright sunlight or ultraviolet radiation.

## TRANSPORTING THE NOTEBOOK

Please use the following guidelines when transporting the Notebook:

- Switch off the Notebook. This will prevent damage to the hard disk. When the Notebook is turned off, the hard disk heads are moved into a safe area.
- Remove any CDs and floppy disks. This will prevent damage to the disks or to the drive heads.
- Close the Notebook and ensure that the cover locks shut.
- Always use the Notebook carrying case. This helps to protect the Notebook from dirt, moisture, jolts and scratches.
- Fully charge your battery and any spare batteries immediately before a long journey.
- Should you need to ship your Notebook, always use the original packaging and make certain the shipper knows the contents contain fragile electronic equipment.
- Wait until the Notebook has reached ambient (room) temperature before turning it on or connecting it to the power adapter. Drastic variations in temperature and humidity can create condensation within the Notebook and may cause it to short-circuit.

## UPGRADES AND REPAIRS

- Only a qualified Service Engineer should perform upgrades and repairs to your Notebook.
- If you do not have the necessary qualifications, go to an appropriate **Service Engineer**. Please contact the **Service Centre** if you are experiencing technical problems with your Notebook.

## SECURING YOUR NOTEBOOK

### SETTING A USER PASSWORD

You can prevent unauthorized access to your Notebook by setting a User Password. When starting the Notebook the password will be requested. The User Password is set in the **BIOS**.

➔ **Attention:** Keep your password in safety place. If you forget your password you do not have the possibility to cancel it. In this case please call your service centre.

To protect your data from unauthorized access, you can also use the security option of Windows<sup>xp</sup>. See also chapter „Data and System Security“ (p. 63).

### USING A SAFETY LOCK

You can prevent theft by using a so called **Kensington-lock**, which can be bought at your local retailer.

The cable wraps around an object and the „T“ shaped end inserts into the Kensington lock port and a key or combination dial is used to secure the lock in place. Please keep your key at a safety place.

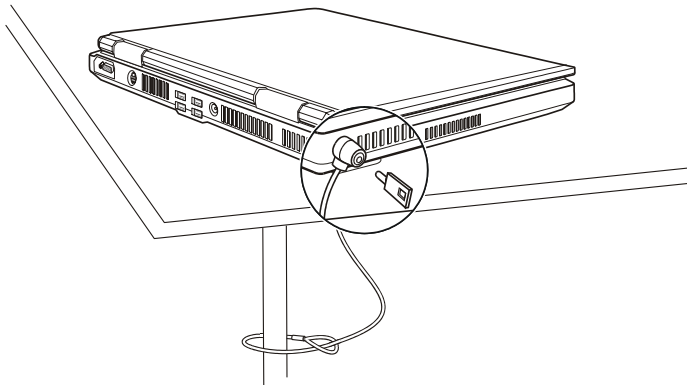

## NOTES FOR SERVICE ENGINEERS

- Before opening the housing, disconnect the Notebook from all power sources and remove any connecting cables. If the Notebook has not been disconnected from the power outlet before being opened, there is a **danger** of severe electric shock. There is also a risk of damage to the components.
- Internal components of the Notebook may be damaged by **electrostatic discharge** (ESD). Perform system upgrades and changes in an **ESD-protected work area**. If no such work area is available, wear an **antistatic wrist strap** or touch a highly conductive metal object. Your service centre can repair damage sustained by inappropriate handling for a fee.
- Use only **original spare parts**.

**CAUTION:** The CMOS lithium batteries cannot tolerate intense pressure, high temperatures or fire. Keep away from children! Danger of explosion if replaced incorrectly. Only replace with a compatible type (CR2032) as recommended by the manufacturer. Lithium-Batteries are **hazardous waste** and need to be disposed of properly. If necessary, we will take back your used CMOS lithium battery.

### **Notes on Laser Radiation :**

Laser devices of Laser Class 1 to Laser Class 3b may be used in the Notebook. Where the Notebook housing remains closed, the device meets the requirements of **Laser Class 1**. By opening the Notebook housing you will gain access to laser devices of up to Laser Class 3b.

- The CD-ROM/CD-RW/DVD/DVD-RW drive contains no user-serviceable parts. Only the **manufacturer** should perform repairs to the CD-ROM/CD-RW/DVD/DVD-RW drives.

When removing and/or opening laser devices, the following guidelines must be observed:

- **DO NOT** look into the laser beam, even while wearing optical protection.
- **DO NOT** allow yourself to be exposed to the laser beam. Avoid exposure of the eyes or skin to direct or stray radiation.



Appendix

<b>Subject</b>	<b>Page</b>
Standards _____	75
Index _____	79





# STANDARDS

---

This Notebook meets the requirements of the following standards:

## ELECTROMAGNETIC COMPATIBILITY

This Notebook meets the following requirements for standards of electromagnetic compatibility and electrical safety:

<b>EN 55022</b>	Information technology equipment - Radio disturbance characteristics - Limits and methods of measurement.
<b>EN 55024</b>	Information technology equipment - Immunity characteristics - Limits and methods of measurement.
<b>EN 61000-3-2</b>	Limits - Limits for harmonic current emissions (equipment input current up to and including 16 A per phase).
<b>EN 61000-3-3</b>	Limits - Limitation of voltage fluctuations and flicker in low-voltage supply systems for equipment with a rated current up to 16 A.

- Keep the Notebook at least one meter (approximately three feet) away from **high frequency** and **magnetic interference sources** (e.g., televisions, loudspeaker cabinets, mobile telephones, etc.) in order to avoid malfunctions and/or loss of data.
- Please note that only **shielded** cables shorter than 3 meters (9.84 ft) should be used for the LPT, COM, USB, IEEE 1394, audio, video and network interfaces with this Notebook.
- When connecting additional components, please observe the *Guidelines on Electromagnetic Compatibility (EMC)*.

## ELECTRICAL SAFETY

### EN 60950

Safety of information technology equipment.

- The connection of devices is limited to equipment that complies with EN60950 "Safety of information technology equipment" or EN60065 "Audio, video and similar electronic apparatus. Safety requirements"
- For U.S. / Canadian purposes: The Notebook should only be connected to equipment which complies with UL 60950 / CAN CSA 22.2 No 60950

## ERGONOMICS

### EN 29241-3

Ergonomic requirements for office work with visual display terminals (VDTs). Visual display requirements.

### EN ISO 9241-8

Ergonomic requirements for office work with visual display terminals (VDTs). Requirements for displayed colours.

## SUPPLEMENTARY INFORMATION

This product has been tested for operation in UK and complies with the European Directives on Radio and Telecommunications Terminal Equipment (R&TTE 1999/5/EC).

## ISO 13406-2 CLASS II

Active matrix LCDs (TFT) with a resolution of 1024 x 768 pixel (XGA), which are in turn composed of three sub-pixels each (red, green, blue), contain about 2.4 million addressable transistors. Because of this very high number of transistors and their extremely complex production process occasionally defective or incorrectly addressed pixels or sub-pixels may occur.

There have been several attempts in the past to define the acceptable number of defective pixels. But this can be difficult and varies widely between different manufacturers.

We, therefore, adhere to the clear and strict requirements of **ISO 13406-2, class II**, for the warranty handling of all TFT display products. These requirements are summarized below.

Within ISO-standard 13406-2 the general requirements regarding pixel defects are defined. Pixel defects are classified into three failure types and four failure classes. Each individual pixel is made up of three sub-pixels in the primary colours (red, green, blue).

**Pixelstructure**

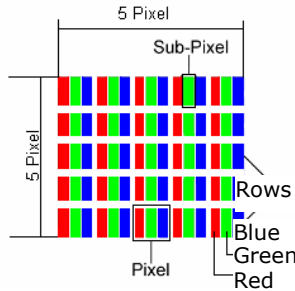

**Types of Pixel Failures:**

- Type 1: A constantly lit pixel (a bright, white spot), even though it is *not* addressed  
A white pixel is caused when all three sub-pixel are lit.
- Type 2: A pixel that does not light up (dark, black spot), although it is addressed
- Type 3: Abnormal or defective red, green or blue sub-pixels.  
(E.g. constantly lit with half the brightness, one colour is not shining, blinking or flickering, but not belonging to Type 1 or 2 Pixel Failures)

In addition: A cluster of type 3 (= 2 or more defective sub-pixels in an array of 5 x 5 pixel). A cluster is an array of 5 x 5 pixel (15 x 5 sub-pixel).

**ISO 13406-2, Class II**

<u>Resolution</u>	<u>Type 1</u>	<u>Type 2</u>	<u>Type 3</u>	<u>Cluster Type 1, Type 2</u>	<u>Cluster Type 3</u>
1024 x 768	2	2	4	0	2
1280 x 854	3	3	6	0	3
1280 x 1024	3	3	7	0	3
1400 x 1050	3	3	8	0	3

**Example:**

A 17" - SXGA-display consists of 1280 horizontal and 1024 vertical picture dots (pixel), which amounts to a total of 1,31 million pixels. Based on one million pixels this translates into a factor of about 1.31.

Class II type failure consequently allows for three defects each of type 1 and type 2 and 7 defects of type 3 and 3 cluster of type 3.

These cases are normally not covered by warranty.

If the number of failures exceeds the figures of any category mentioned above then this may be covered by the warranty.

## **LIMITS OF LIABILITY**

To the extent allowed by local law, except for the obligations specifically set forth in this warranty statement, in no event shall the company or its third party suppliers be liable for direct, indirect, special, incidental, or consequential damage, whether based on contract or any other legal theory and whether advised of the possibility of such damages. This includes loss or damage of personal data on your Notebook.

## **LOCAL LAW**

This warranty statement gives you legal rights. You may also have other rights that vary from jurisdiction to jurisdiction. To the extent this warranty statement is inconsistent with local law, certain disclaimers and limitations of this statement may not apply to the customer.

## **MAKING COPIES OF THIS MANUAL**

This manual contains information protected by law. All rights are reserved. Copyright law prohibits duplicating this information in mechanical, electronic, or any other form, without the written approval by the manufacturer.

# INDEX

---

## **A**

- All programs .....21
- Ambient temperature ..... 7
- Appendix.....73
- Audience..... i

## **B**

- Battery operation ..... 10, 25
  - Battery Power.....25
  - Charging the Battery.....25
  - Checking the battery level ..26
- Battery Power .....25
- BIOS Setup-Program .....57
- BIOS Utility
  - Navigating.....58
- Burning CDs ..... See writing CDs

## **C**

- Cabling ..... 9
- CardBus .....51
- Care of displays .....68
- CD-ROM.....39
- CD-RW Drive .....39
- CDs
  - Data.....43
  - Music.....43
  - Writing .....43
- Charging the Battery.....25
- Checking the battery level .....26
- Cleaning agents .....68
- Cleaning and Care .....68
- Clone desktop .....29
- Connection options .....53
- Connectors
  - Audio IN .....45
  - Audio OUT.....45
  - External monitor .....29
  - Microphone IN .....45
  - Modem .....46
  - PC card.....51
  - SPDIF.....45

- TV ..... 31
- USB .....53
- Control panel..... 22
- Copyright© ..... ii

## **D**

- Data and system security ..... 63
- Data entry ..... 32
- Data security..... 3, 63
- Deleting files ..... 38
- Desktop..... 21
- Digital Signatures ..... 56
- Directories ..... 38
- Disc-Drive..... 39
- Discs
  - Handling ..... 39
  - Loading ..... 40
  - Playing DVD movies ..... 42
  - Playing music CDs.....42
  - Removing ..... 41
  - Writing ..... 43
- Display ..... 28
  - Opening and closing the display ..... 28
- Driver support ..... 67
- Drivers .....38, 55
- DVD movies ..... 42
- DVD-Drive ..... 39

## **E**

- Electrical safety ..... 76
- Electromagnetic compatibility 75
- EMC.....75
- Emergency Ejection of a blocked Disc..... 41
- Enter personal details ..... 20
- Ergonomics ..... 76
- Extend desktop..... 30
- External audio ports ..... 45
- External monitor .....15, 29
  - Clone desktop ..... 29
  - Extend desktop..... 30

---

<b>F</b>	
FAQ.....	61
Fast Ethernet-Network .....	48
Files	
Deleting .....	38
Finding files .....	37
First Aid .....	59
Frequently asked questions....	61

---

<b>G</b>	
Getting Started .....	19

---

<b>H</b>	
Handling .....	17
Hard drive.....	37
Partitions .....	37
HD .....	See Hard drive
Help .....	54
Help with software.....	55

---

<b>I</b>	
Icons .....	22
Indicators	
Capital Lock.....	16
Hard disk drive access.....	16
Num Lock.....	16
Optical drive access .....	16
Scroll Lock .....	16
Installing a PC card.....	52
ISO 13406-2 Class II .....	76

---

<b>K</b>	
Kensington-lock .....	70
Keyboard .....	32

---

<b>L</b>	
Laser radiation .....	71
License agreement .....	20

---

<b>M</b>	
Main components .....	35
Main Operation .....	24
Maintenance .....	68
Care of the TFT display.....	68

Cleaning and Care.....	68
Transporting the notebook .	69
Maintenance programs.....	63
Modem .....	9, 46
Mouse .....	33
MPEG2 .....	42
MusicMatch Jukebox .....	42

---

<b>N</b>	
Network .....	47
Fast Ethernet-Network.....	48
Troubleshooting .....	49
What do you need for	
networking? .....	48
What is a Network? .....	47
Wireless LAN .....	50

---

<b>O</b>	
On/Off button.....	23
Operational safety.....	4
Optical drive.....	14

---

<b>P</b>	
Partitions .....	37
Password reset disk.....	63
PC card	
Installing .....	52
Removing .....	52
PC card slot.....	51
PCMCIA .....	51
Peripheral devices .....	55
Playing DVD movies .....	42
Playing music CDs.....	42
POST.....	65
Power.....	27
Turning off your computer..	22
Power adapter .....	8
Power management.....	27
Power On Self Test.....	65
Power supply.....	23
Battery operation.....	25
Suspend mode .....	27
Main Operation .....	24
PowerDVD .....	42
Program bar.....	21

Programs	
Installing.....	64
Location.....	38

---

## **Q**

Quality.....	ii
--------------	----

---

## **R**

Recovery.....	64
Windows <sup>XP</sup> .....	64
recovery points.....	64
Removing a PC card.....	52
Repairs.....	69
Running the Bios Setup.....	57

---

## **S**

Safety	
Data.....	38
Safety and maintenance.....	1
Safety instructions.....	3
Additional safety instructions	5
Ambient temperature.....	7
Battery operation.....	10
Cabling.....	9
Data security.....	3
General safety information...	4
Modem.....	9
Operational safety.....	4
Optical drive safety.....	6
Power adapter.....	8
Set-Up location.....	7
TFT Display safety.....	6
Touch pad.....	9
Upgrades and repairs.....	69
Screen resolution.....	29
Search.....	37
Securing your Notebook.....	70
Serial Number.....	i
Service.....	ii
Service engineers.....	71
Setting a User Password.....	70
Set-Up Location.....	7
Software.....	54
for playing CDs.....	42
Software help.....	55

Sound card.....	45
Standards.....	75
Electrical safety.....	76
Electromagnetic compatibility	
.....	75
Ergonomics.....	76
Standby mode.....	27
Start button.....	21
Support.....	67
Suspend to disk.....	27

---

## **T**

Task bar.....	22
Touch pad.....	9, 33
trademarks.....	ii
Transport.....	69
Troubleshooting.....	65
Errors and possible causes .	66
Turn off computer.....	22

---

## **U**

Universal Serial Bus.....	53
Upgrades and repairs.....	69
Use of PC cards.....	51
Using a safety lock.....	70

---

## **V**

Views	
AC power indicator.....	14
Battery charge indicator.....	14
Device indicators.....	13
Display catch.....	14
Front side.....	14
Kensington lock.....	14
Keyboard.....	13
LAN Port (RJ-45).....	14
Left side.....	14
Line out.....	14
Microphone.....	13
Microphone in.....	14
Modem Port (RJ-11).....	14
Monitor (external).....	15
Open notebook.....	13
Optical drive.....	14
PC card slot PCMCIA.....	14

Power ON/OFF .....	13
Power socket .....	15
Rear Side .....	15
Right side.....	14
Stereo speaker .....	13
S-Video port .....	15
TFT Display .....	13
Touchpad .....	13
USB port .....	14, 15
Views of the notebook.....	11
Voyants	
Wireless LAN .....	16

---

**W**

Windows activation.....	57
-------------------------	----

Windows Logo testing .....	56
Windows Media Player .....	42
Windows XP	
Control Panel.....	22
Desktop.....	21
Help.....	54
Help.....	22
Help and support .....	54
Manual .....	54
Recovery point .....	55
Tour.....	54
Windows <sup>xp</sup>	
Recovery .....	64
Wireless LAN .....	50
Writing CDs.....	43